

# ELMDENE

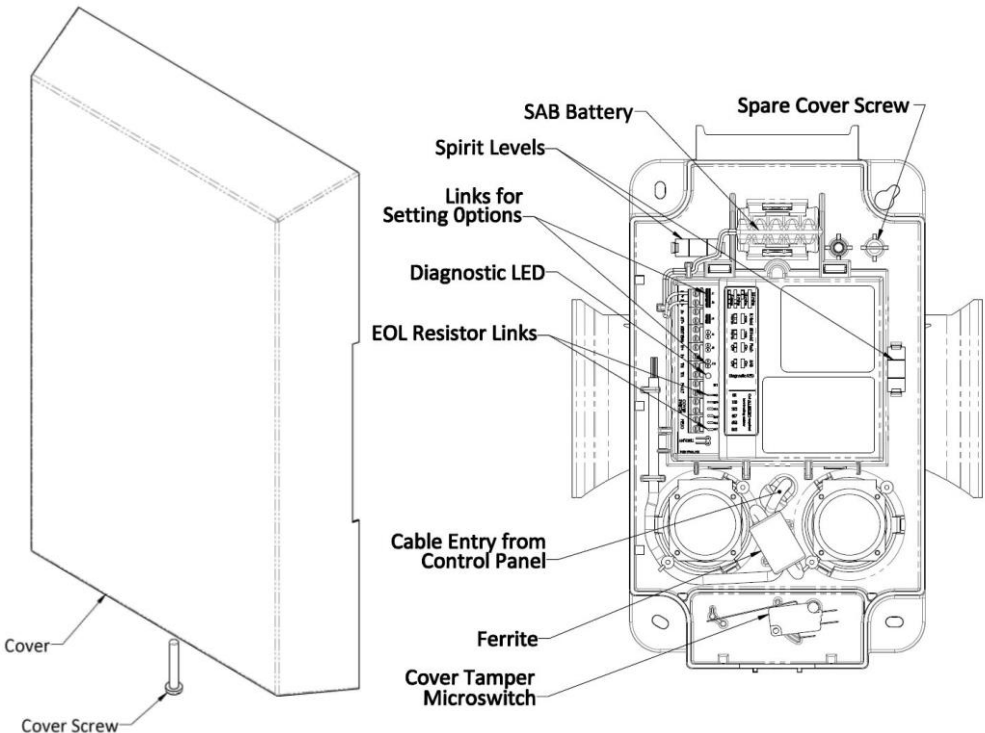
Protecting People & Property

**Elmdene International Ltd**  
3 Keel Close, Interchange Park,  
Portsmouth, Hampshire, PO3 5QD, UK

Tel: +44(0)23 9269 6638  
Fax: +44(0)23 9266 0483  
Web: [www.elmdene.co.uk](http://www.elmdene.co.uk)

## RAPIER-6510 External Sounder

- High Integrity Polished Stainless Steel,
- High Efficiency Operation
  - 10mA standby,
  - 180mA sounding
- Low Power LED Twin Strobe
- Comfort LEDs
- Battery and Piezo Test with Fault Output
- Remote Test Input
- Ring Line Monitoring
- Silent Engineer Start-up
- Integral EOL Resistor Links
- Spirit Levels for Ease of Installation
- Audible Tamper to Assist Commissioning
- Selectable Sound Cut-off Timer
- Full SAB Capability



## FEATURES

The RAPIER-6510 sounder is a high specification warning device designed for use in installations requiring the highest levels of security protection. With its high quality stainless steel cover the RAPIER-6510 is ideal where product integrity is fundamental. The contemporary appearance of the highly polished cover delivers an aesthetically pleasing look in every installation. The RAPIER-6510 fully meets the requirements of EN50131-4 as a self-powered warning device for external applications at Security Grade 3.

## OPERATION

The RAPIER-6510 sounder is used for notification of an alarm condition as generated within an intruder, hold-up or other alarm system. In response to commands from the alarm system control panel, the sounder will emit a high intensity sound and/or operate a visual flash.

The RAPIER-6510 will detect any attempt to gain unauthorised access to the sounder by removal of the cover, or any attempt to remove it away from its mounting surface. This will generate a tamper signal which is normally fed back to the alarm control panel. Integrity of the Trigger Command (Ring Line) connection is constantly monitored and will cause the unit to self activate if loss of connection is detected, with R- HOLD link NOT fitted the unit will also report a tamper to the control panel.

The RAPIER-6510 is classified a self powered sounder and has an on-board battery which is recharged via the external power source. This battery is used to operate the sounder if the external power is removed. The sounder can be configured to self actuate (SAB Mode ON) in the event that a tamper condition is detected or the external power to the sounder is removed.

Every 24 hours the RAPIER-6510 performs a self test to check the integrity of its on-board battery, its battery charging circuit and its piezo transducers. If an error condition is detected, a fault signal is generated. This is normally connected back to the control panel. This self-test can be triggered at any time by a Remote Test command sent from the control panel. An on-board diagnostic LED guides the maintenance engineer to the source(s) of the fault.

To assist with commissioning, the RAPIER-6510 has an Engineer Mode to provide silent start-up and Tamper Tones that indicate the correct closure of the tamper detection switches.

Two Comfort LEDs are used to provide a heart-beat type visual indication when the Rapier is not sounding. These may be disabled.

## FUNCTIONAL INFORMATION

### Tamper Circuit for Single or Multiple Cascade Installations

The RAPIER-6510 sounder has provision for inclusion of an end of line resistor in the tamper circuit for both single (Figure 1) and multiple cascade installations (Figure 2). In cascade installations with two or more sounders, the TS (Tamper Source) will normally be connected to the TR (Tamper Return) of the next sounder except for the last unit which will have TS linked to H-. Only ONE end-of-line resistor should be selected in the last sounder, all other units should have OQ selected.

### Engineer Mode

This selects silent start-up and silent maintenance. The ENG input may be brought back to the control panel and connected to a programmable output. Switching this control panel output high when maintenance is required will prevent the sounder from self activating when the cover is removed or R-activated. The Tamper output is open when ENG is high, this prevents inadvertent system setting with the sounder left in Engineer Mode (when SAB Mode = on).

### Self Test and Fault Output

The RAPIER-6510 performs a self test every 24 hours. This function tests the condition of the battery and piezo sounders. If a fault is found the Fault output will open. The fault source can be identified using the Diagnostic LED - see "Diagnostics". This is ONLY enabled when the cover is opened (top tamper active) for longer than 5s and the RTST input is low or not connected.

The Fault output will be cleared (output closed) when:

- the fault has been cleared, e.g. battery (re)connection
- the fault has been cleared and the sounder performs its next 24hour self test
- the fault has been cleared and a self test is triggered using the Remote Test (RTST) input
- the fault has been cleared and the sounder has been disconnected from H+ AND the SAB battery has been disconnected (hardware reset)















### Remote Test

With the cover closed and ENG low, taking the Remote Test (RTST) input high will force a self test. The Fault output is immediately opened to acknowledge receipt of the Remote Test instruction. The condition of the piezos and battery is immediately tested. Any fault found will be indicated by the Fault output remaining open after 10s. The Fault output will remain open until the fault has been cleared and another Self Test or Remote Test has been performed. If the self test has passed, the Fault output will close after 10s of starting the Remote Test.

## OPTIONS SELECTION

Table 1 summarises the link options for various Modes of operation.

**Table 1: Option Selection Links**

Sound Cut-Off Timer	5 sec 	5 min 	10 min 	15 min* 
R Hold** (Sound Trigger Hold-Off)	+ve 	None* 	<b>KEY</b>  Link FITTED  Link NOT Fitted	
ST Hold (Strobe Trigger Hold-Off)	+ve 	None* 		
Comfort LEDs	Flash* 	Off 		
SAB	On* 	Off 		

\* Factory default setting.

\*\* Note: When R HOLD link is fitted, R- cut line detection will not report a tamper to control panel.

### Sound Cut-off Timer

The RAPIER sounder will automatically stop sounding after the time period selected by the Sound Cut-off Timer link, Table 1, irrespective of the status of the sound trigger (R-) input. The 5s option is provided to reduce nuisance noise during testing.

### Hold Off Facility for Sound (R-) and Strobe (ST-) Trigger Inputs

A Hold Off facility is provided by links R Hold and ST Hold to enable triggering of the sounder and strobe from a control panel configured for positive hold-off signalling, Table 1.

Links R Hold and ST Hold connect internal pull-down resistors to the R- and ST- trigger inputs. When these links are FITTED, a +12V voltage must be applied to R- and ST- to prevent (HOLD OFF) the sounder from sounding and the strobe flashing. Trigger by removing +12V.

When the R Hold and ST Hold links are NOT FITTED, the control panel must supply a transition from +12V to 0V on R- or ST- to trigger sound or strobe.

### Comfort LEDs

Twin comfort LEDs may be disabled by removing the Comfort LED link, Table 1. When enabled, the LEDs flash at a rate of approximately 1Hz.

### SAB Mode

SAB selects the response of the sounder to various tamper conditions according to the following table:

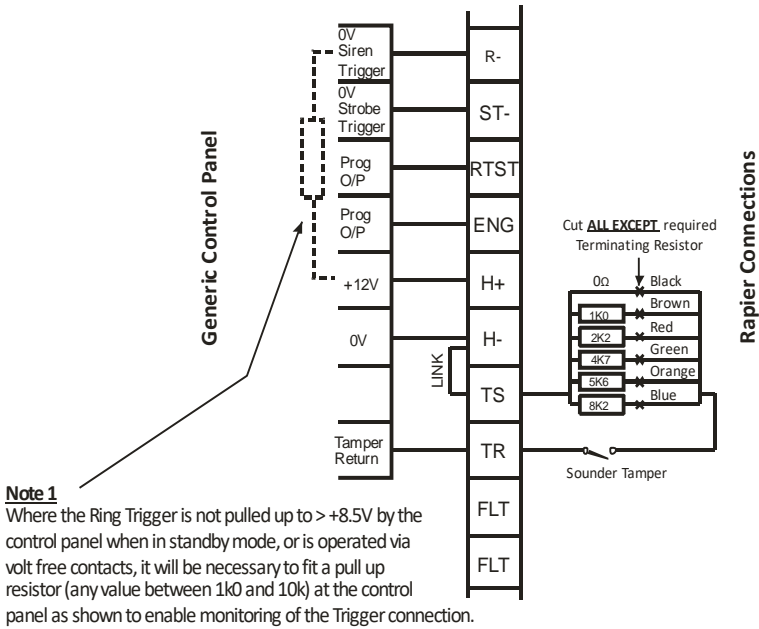
**Table 2: SAB Mode Tamper Condition**

Tamper Condition	SAB Mode		Tamper Output	Fault Output
	ON	OFF		
Cover removed	Sounder Active	Sounder Silent	Open	Closed
Removed from mounting				
Connection to R- is cut (R HOLD link NOT fitted)				
H+ or H- power connections cut		Sounder Active	Closed	
Connection to R- is cut (R HOLD link fitted)				

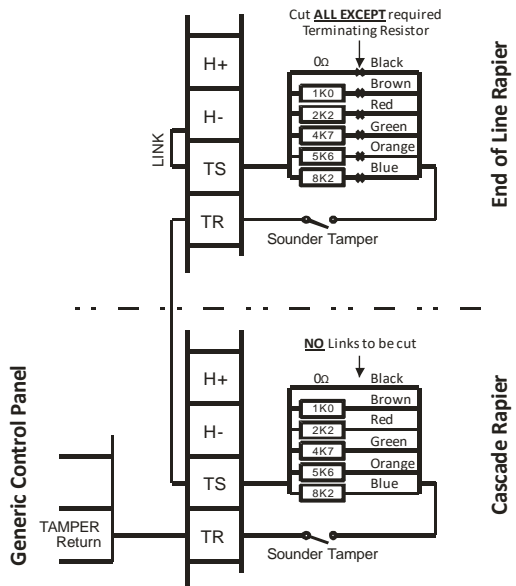
With SAB Mode OFF, the Tamper Output will still open and signal an active tamper condition back to the control panel under the conditions given in Table 2. If required the sounder can be activated using a normal sound trigger command from the control panel.

## CONNECTIONS

BT+	POSITIVE (RED) Connection to Battery
BT-	NEGATIVE (BLACK) Connection to Battery
R-	Sounder trigger input
ST-	Strobe trigger input
RTST	Remote Test Trigger Input
ENG	Engineer Mode Enable. Apply 9-15v to activate
H+	+ve power connection (9-15vdc)
H-	0v power connection
TS, TR	Tamper Output: volt free contacts
Fault	Fault output: volt free contacts



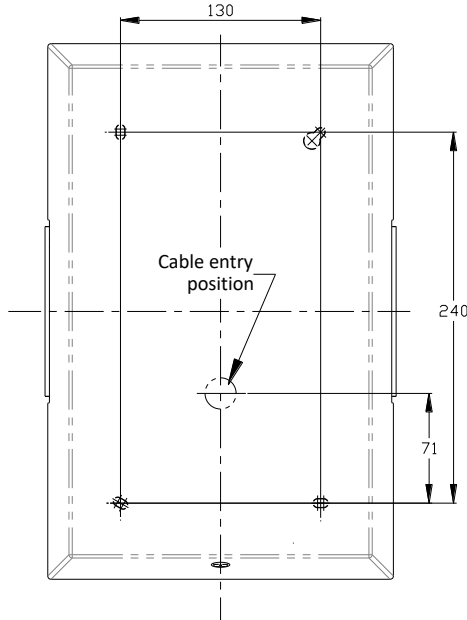
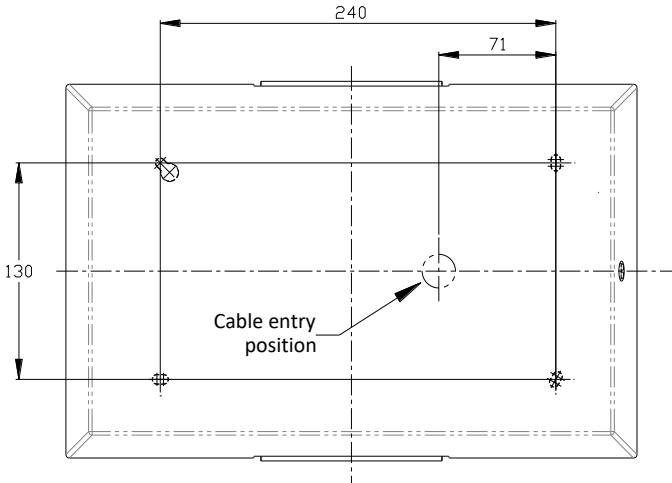
**Fig 1: Single RAPIER-6510 Tamper Connection**

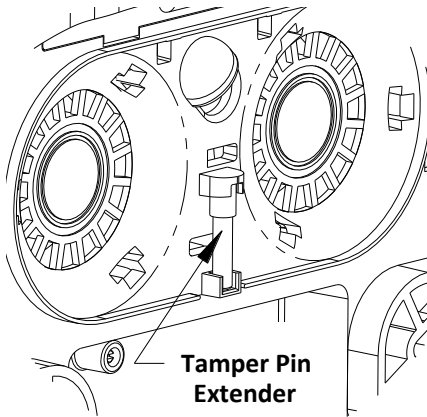


**Fig 2: Multiple Cascade RAPIER-6510 Tamper Connection**

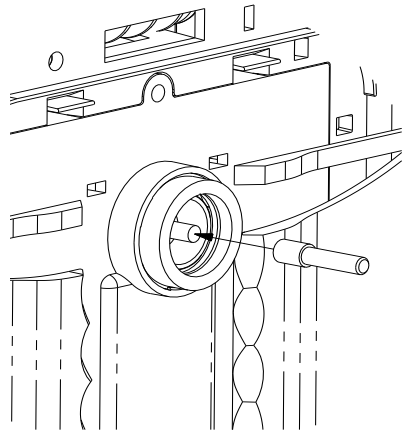
**INSTALLATION AND SET-UP**

- 1) Select a suitable mounting position for the RAPIER-6510 sounder.
- 2) Drill holes as required for fixing the backplate to the wall and for cable entry via the rear of the unit. Use the spirit levels to achieve correct alignment.

**Fig 3a: Portrait Mounting****Fig 3b: Landscape Mounting**

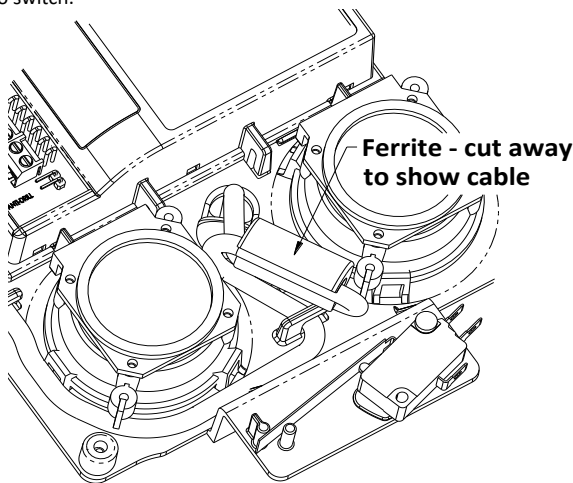


**Fig 4a: Parked Tamper Pin Extender**



**Fig 4b: Fitment of Tamper Pin Extender**

- 3) Fit tamper extender (if required), Figure 4, and trim to desired length (see commissioning).
- 4) Route cable from control panel through cable entry cowl.
- 5) Loosely fit backplate to wall.
- 6) Fit ferrite onto cable as shown in figure 5, ensuring that it does not interfere with the operation of the micro switch.



**Fig 5: Fitting of Ferrite**

- 7) Strip cable as required and loop sheathed part around cable restraint.
- 8) Connect cable cores to terminations. Figure 1, shows connections for generic control panels.

## COMMISSIONING

- 1) Fit timer links for required sound cut-off time.
- 2) Set the strobe and ring trigger Hold Off links as required.
- 3) Fit SAB mode and Comfort LED mode links as required.
- 4) Select the tamper end-of-line resistor as required.
- 5) Connect ENG input to H+ or to a switched output of control panel set high.
- 6) Apply power to the sounder via H+ and H- from control panel.
- 7) Connect the black battery lead to BT- (slide sleeve to expose conductor).
- 8) Check tamper signal is present at control panel (circuit open).
- 9) Move sounder backplate towards mounting surface to check rear tamper operation: single click from piezo = tamper close, double click = tamper open. If tamper pin extender has been fitted, trim extender length using a pair of pliers or side cutters as required.
- 10) Fix backplate securely to wall.
- 11) Fit cover and tighten cover screw to check cover tamper: single click from piezo = tamper close, double click = tamper open.
- 12) Once the cover is fitted and the cover fixing screw tightened, the unit will perform a self test. This takes approximately 5 seconds. If the battery is faulty the unit will indicate this with a continuous series of fast clicks. If the rear tamper is not fully closed, the unit will emit a continuous series of slow clicks.
- 13) Remove cover.
- 14) If ENG is connected to H+, then remove this link – note: sounder will activate if SAB Mode is selected.
- 15) Re-fit outer cover and fasten cover fixing screw.
- 16) At control panel, set ENG low if connected to a switched output of control panel.
- 17) At control panel, check that tamper signal is now cancelled (circuit closed).
- 18) Test strobe operation by triggering ST- input.
- 19) Test sounder by triggering R- input.

## MAINTENANCE

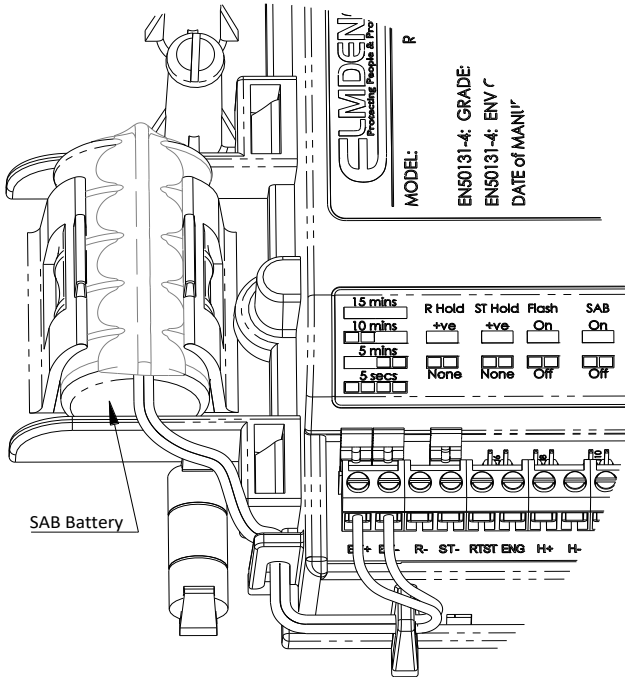
The RAPIER-6510 sounder should be tested for correct operation on a periodic basis. A minimum of one check every 12 months is recommended. The following features should be verified on each maintenance visit:

- 1) Correct operation of sounder and strobe from control panel signals
- 2) Correct operation of cover and rear tampers.
- 3) Remove the H+ supply from the control panel and check that the internal battery voltage as measured between BT+ and BT- is greater than 6.0v dc. If the battery voltage is less than this value replace the battery and re-connect observing CORRECT polarity.
- 4) Check for signs of significant water or insect ingress. Clean as necessary.



**SAB BATTERY REMOVAL**

The SAB battery may be removed for disposal at end of product life or if it is detected faulty by the sounder self test. To remove the battery, disconnect red and black leads from BT+ and BT- and unclip battery from holder, Figure 6. To fit a new battery, clip into holder, route battery cables around clips as shown below and reconnect positive (RED) lead to BT+ and negative (BLACK) lead to BT-.  
**IMPORTANT:** Ensure correct polarity of connections and that exposed battery leads **DO NOT** accidentally touch.



**Fig 6: SAB Battery Removal and Replacement**

***Dispose of used batteries in accordance with all national and local regulations***

**DIAGNOSTICS**

**NOTE: Commissioning Mode only activated when ENG is connected to 9-15vdc**

Commissioning Tones	Status Indicated	Action
Single Click	Tamper closing – front or rear	Use to ensure that the rear tamper has been trimmed or extended to the correct length, or that the cover has been fully closed.
Double Click	Tamper opening – front or rear	Use to verify correct operation of tamper circuit
Continuous slow clicks	Rear tamper not closed when cover tamper is closed	Remove unit from wall and adjust rear tamper until it closes when the unit is correctly fitted.
Continuous fast clicks	Battery not connected or faulty when cover tamper is closed	Open cover and check that battery is correctly connected.

**NOTE: Diagnostic LED only activated when Cover is open**

Diagnostic LED	Status Indicated	Action
Single Flash	Battery voltage low	Change battery (unless newly fitted and is still charging)
2 Flashes	Battery test failed	Change battery
3 Flashes	Piezo self test failed	Change sounder
4 Flashes	Battery charger failure	Change sounder

**FAULT FINDING**

Symptom	Fault	Action
Sounder activated in non-alarm condition and tamper shows at panel	Cover not closed correctly.	Check cover closed and screw secure.
	Rear tamper pin not correct length	Correct rear tamper pin length.
	R- not pulled up to +12V in standby mode	Fit pull up resistor to R- at control panel. See Fig 1, Note 1
Sounder stops after 5s	Incorrect timer link setting	Set correct timer jumper links.
Cannot SET control panel (due to sounder tamper)	Tamper output open due to ENG input still connected to H+	Disconnect ENG from H+ in sounder or set control panel programmable output low.
	Tamper Source (TS) not connected to H- for single sounder or to Tamper Return (TR) for cascaded sounders	Refer to connection diagrams for single and cascaded sounders (Figures 1 and 2).
	Total resistance of tamper circuit too high for multiple sounder installations	Reduce number of cascaded sounders on one tamper loop.
	Cover or Rear tamper switch not closed.	Check cover and rear tamper switches fully closed.
	Ring trigger signal (R-) disconnected (floating)	Ensure R- pulled up to above 8.5V.
Fault output open	Battery not connected	Check battery connections to terminal block.
	Battery faulty or voltage low	Replace battery.
	Piezo fault	Return unit to manufacturer.
	Battery charger faulty	
Clicking noise from sounder during commissioning	See Commissioning Mode table.	

**DISPOSAL OF PRODUCT AT END OF LIFE**

This product falls within the scope of EU Directives 2012/19/EU Waste Electrical and Electronic Equipment (WEEE) and 2014/35/EU (Battery). At the end of life, the product must be separated from the domestic waste stream and disposed via an appropriate approved WEEE disposal route in accordance with all national and local regulations.

Before disposal of the product, the SAB battery must be removed, see Figure 6, and disposed separately via an appropriate approved battery disposal route in accordance with all national and local regulations. Package used batteries safely for onward transport to your supplier, collection point or disposal facility.

***Caution: Risk of fire or explosion  
if bare battery wires are allowed to touch.***

See Specification for battery type information. The battery is marked with the crossed out wheellie bin symbol, which may include lettering to indicate cadmium (Cd), lead (Pb), or mercury (Hg).

For more information see: [www.recyclethis.info](http://www.recyclethis.info)

**SPECIFICATION**

Sound Output	113dB(A) peak @ 1m Modulated tone.
Power Supply	9.0 – 15.0Vdc, 13.8Vdc nominal
Current Consumption	10mA at 13.8vdc (quiescent)
Battery charging	26mA when charging fully discharged batteries
Sounding	180mA max
Strobe	40mA max
Cut-off Timer	Selectable 5s, 5, 10, 15 minutes
Battery	6V 320mAh NiMH - Battery recharge in less than 24 hours (Following 2 x 15 minute sounding)
Battery Low Voltage Detection	5.3V ±0.2V
Strobe	LED, 1Hz flash rate reducing to 0.5Hz after 15 minutes
Tamper	Cover and Rear
Tamper Output	Volt free contact, maximum 16Ω resistance Max 100mA current rating
Fault Output	Volt free contact, maximum 16Ω resistance Max 100mA current rating
Sound Trigger Input	R- < 3.5Vdc = sound ON R- > 8.5Vdc = sound OFF 0.3mA max
Strobe Trigger Input	ST- < 6.5Vdc = strobe flash ON ST- > 6.6Vdc = strobe OFF 1.5mA max
Fixings	No. 10 (M5) self tapping screws (4-off)
Cover Material	Polished stainless steel
Backplate Material	Polycarbonate
Lens Material	Polycarbonate
Operating Temperature	- 25°C to +60°C
Storage Temperature	- 25°C to +70°C

**COMPLIANCE**

This product meets the essential requirements of the following EU Directives:

EMC:	2014/30/EU
RoHS2:	2011/65/EU
WEEE:	2012/19/EU
Battery:	2013/56/EU



EN50131-4:2009                      Security Grade: 3  
   Environmental Class: IV

INCERT Certified (pending)                      <<Approval Number>>  
Certification Body                      Telefication B.V.

Edisonstraat 12A  
Zevenaar, 6902 PK  
The Netherlands  
+31 (0) 316 - 583 180  
<http://www.telefication.com>

This product is suitable for use in systems designed to comply with PD6662:2017 at: **Grade 3 and Environmental Class IV.**

*The packaging supplied with this product may be recycled.  
Please dispose of packaging accordingly.*